

PD4104

PRODUCT DESIGN STUDIO

WATER VESSEL

CAROLYN O'DONOGHUE

15153924

RESEARCH	3-6
IDEATION	7-8
CONCEPT DEVELOPEMENT	9-11
FINAL PRESENTATION	12

# RESEARCH



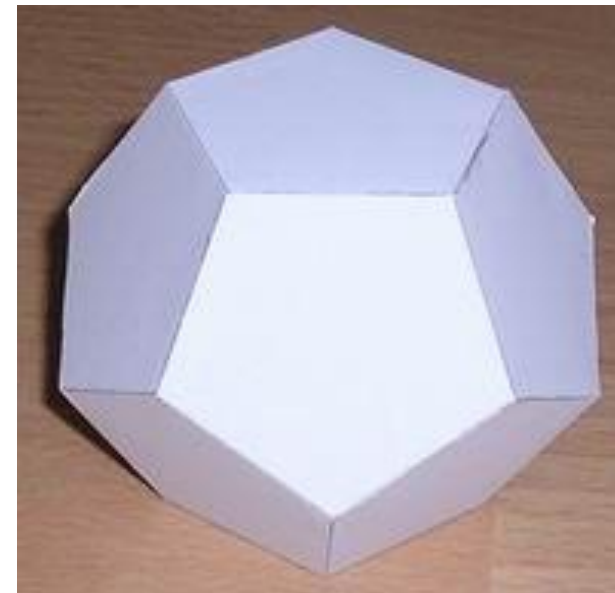



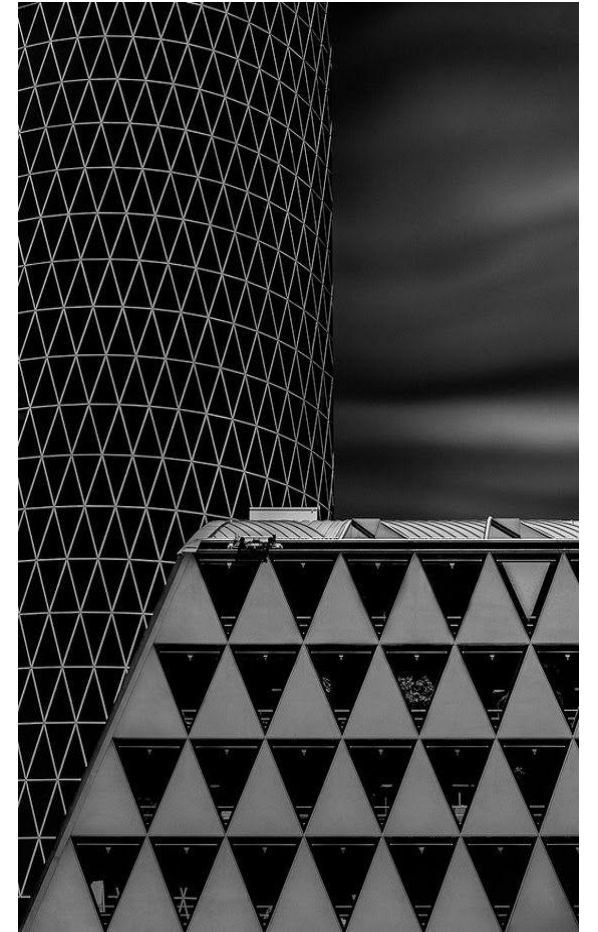

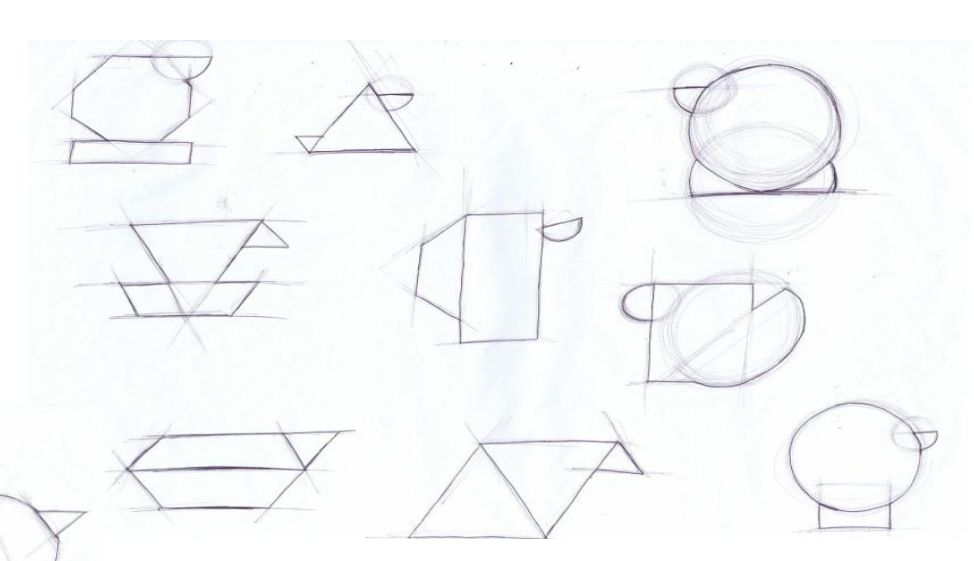
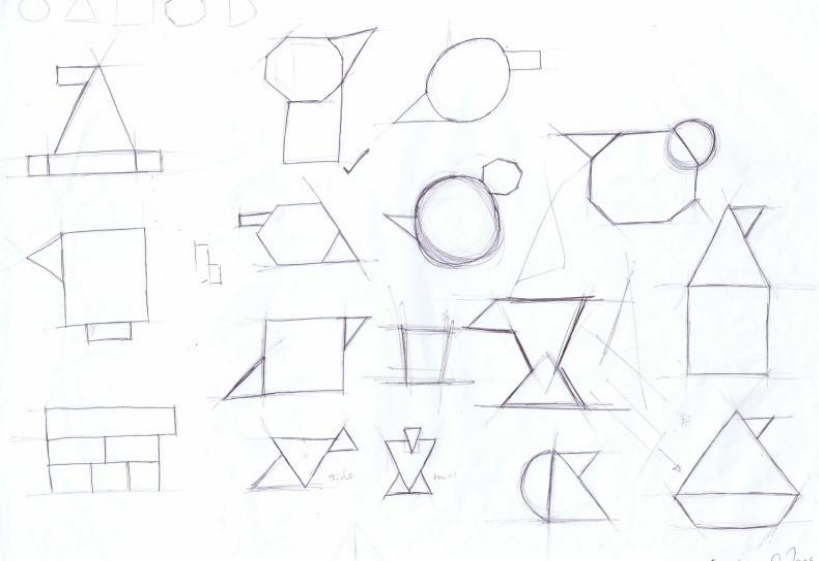

# IDEATION 1

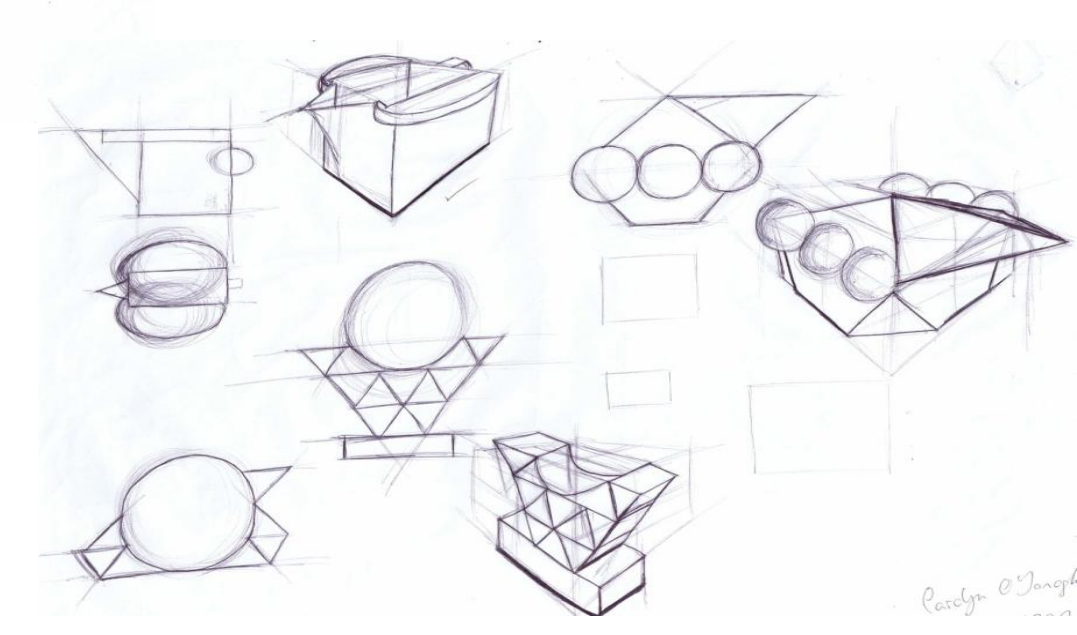
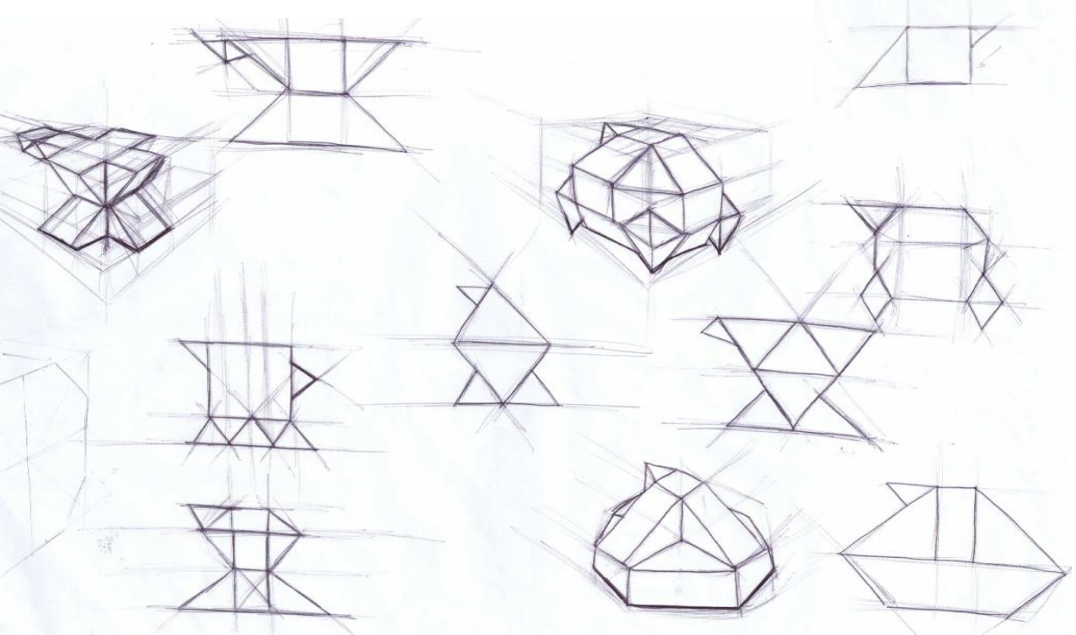
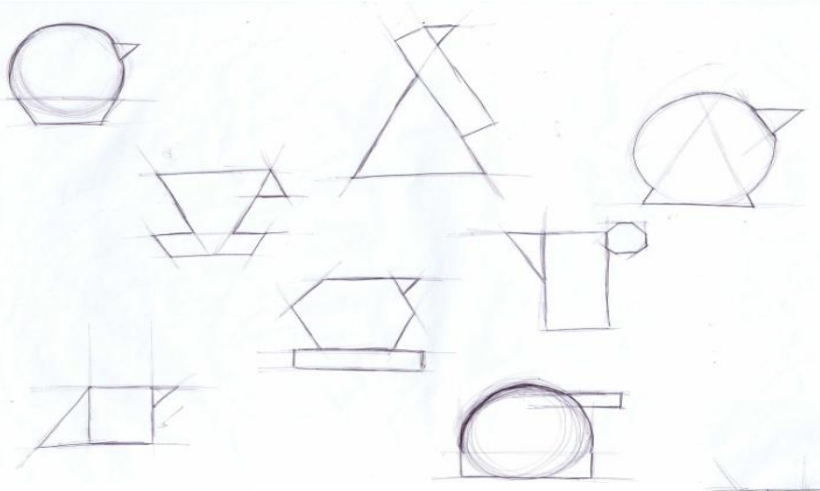

Carolyn & Jonathan

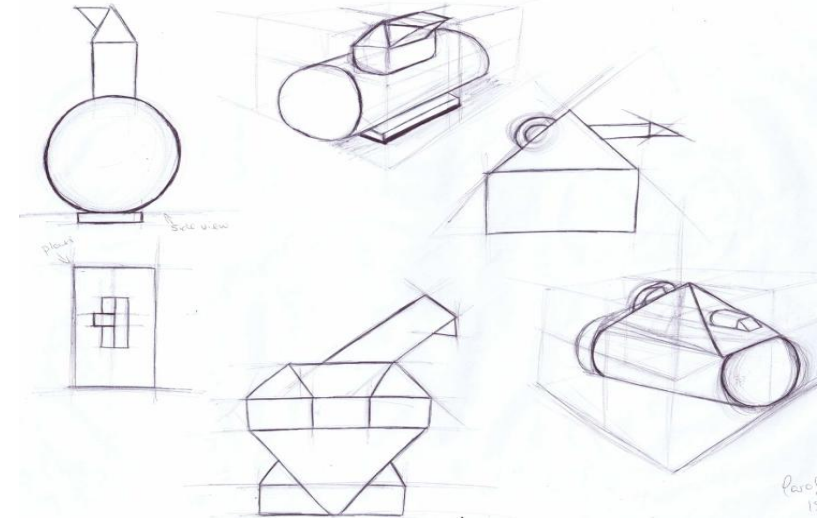
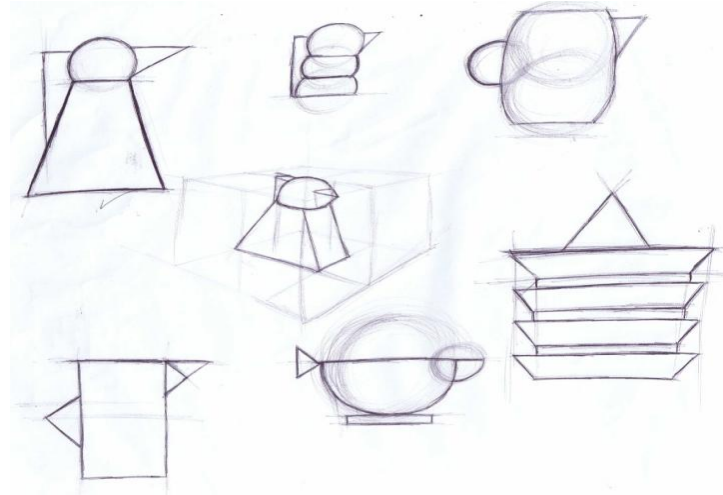
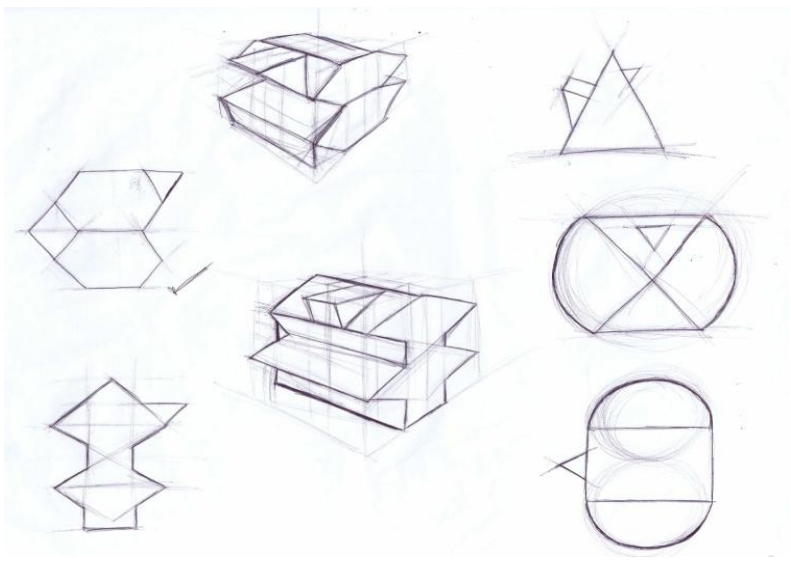

# IDEATION 2

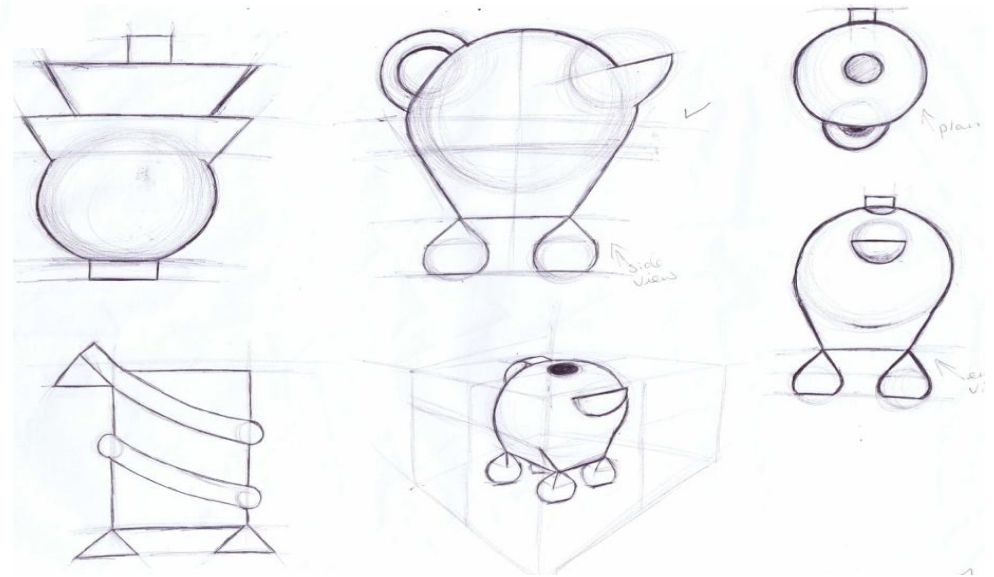
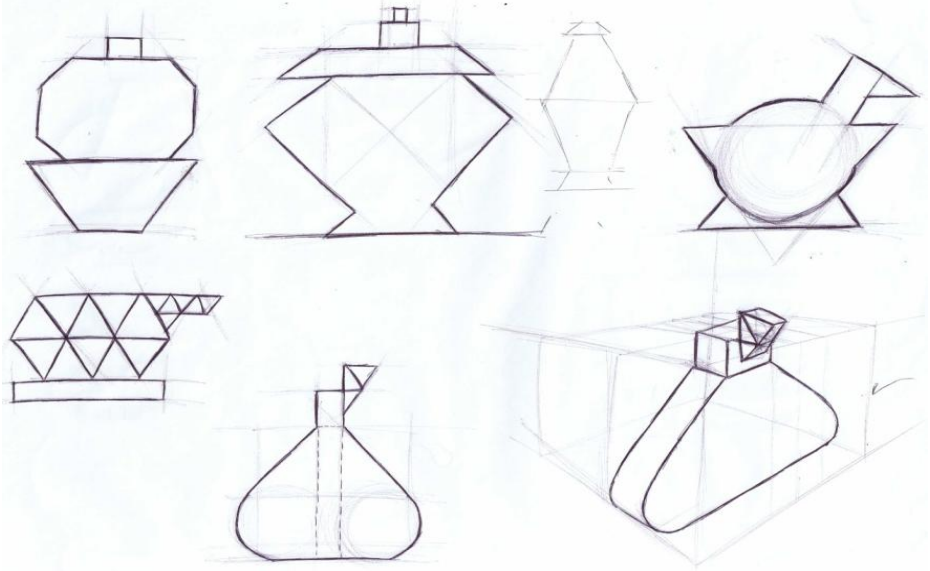



# CONCEPT DEVELOPMENT 1

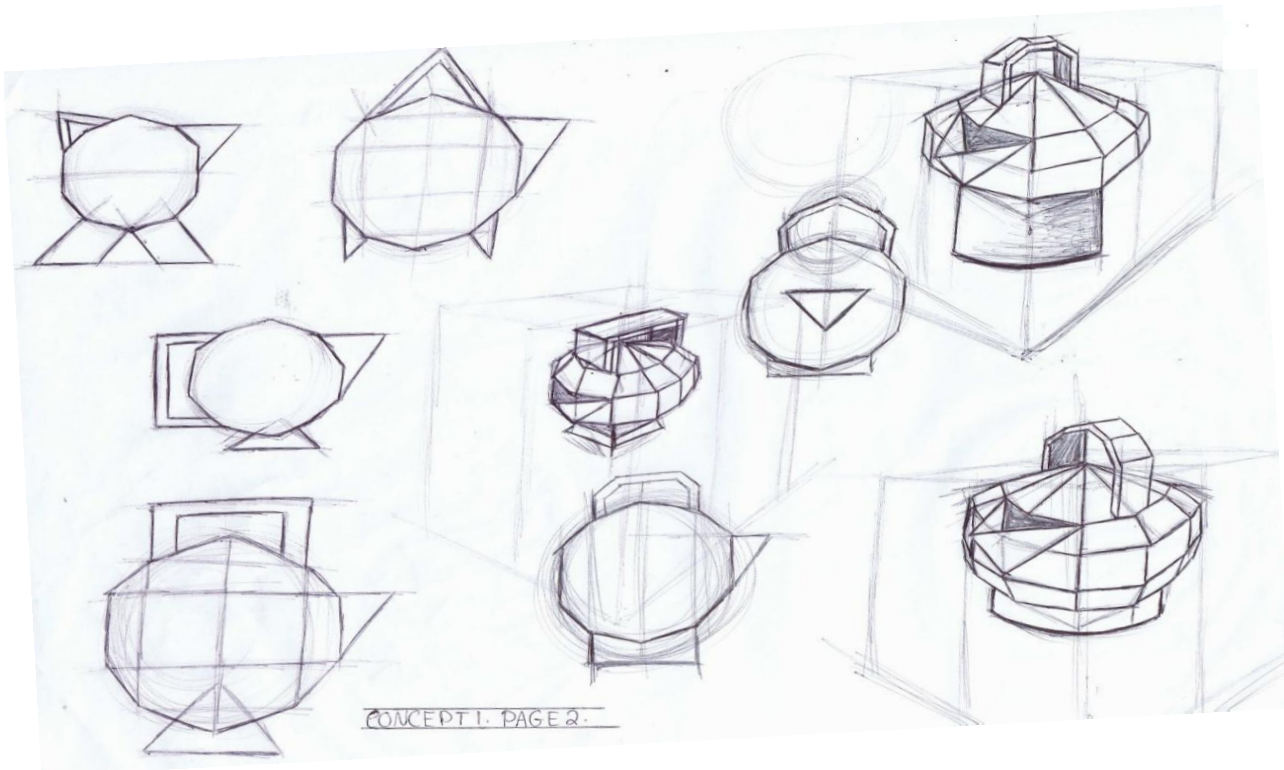
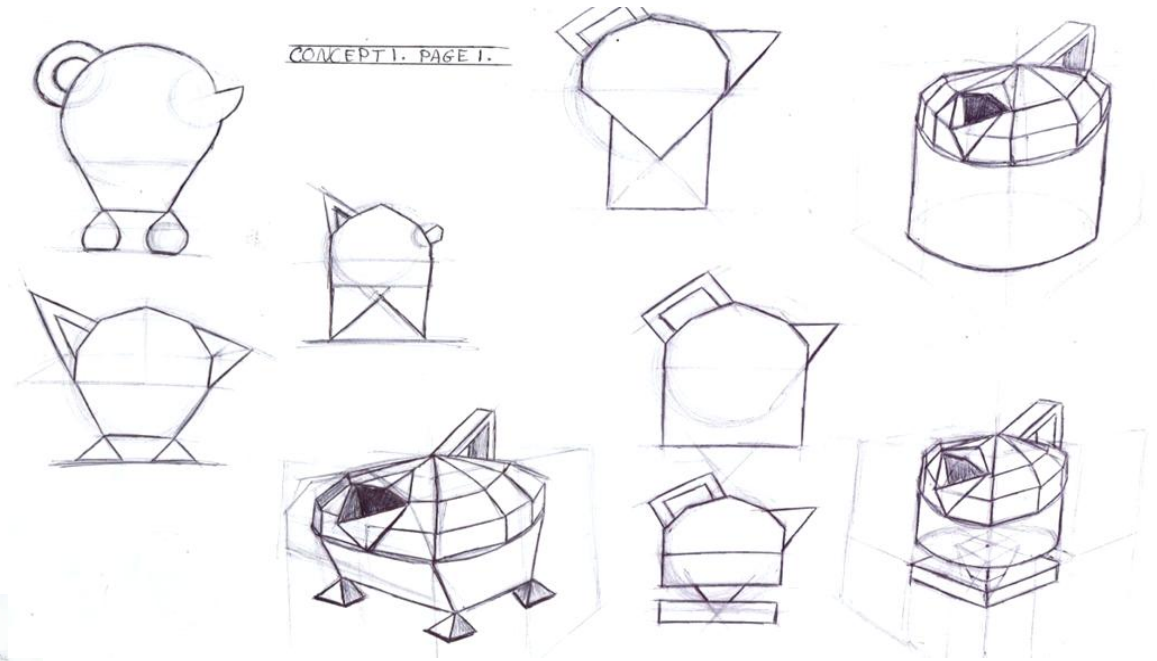

# CONCEPT DEVELOPMENT 2

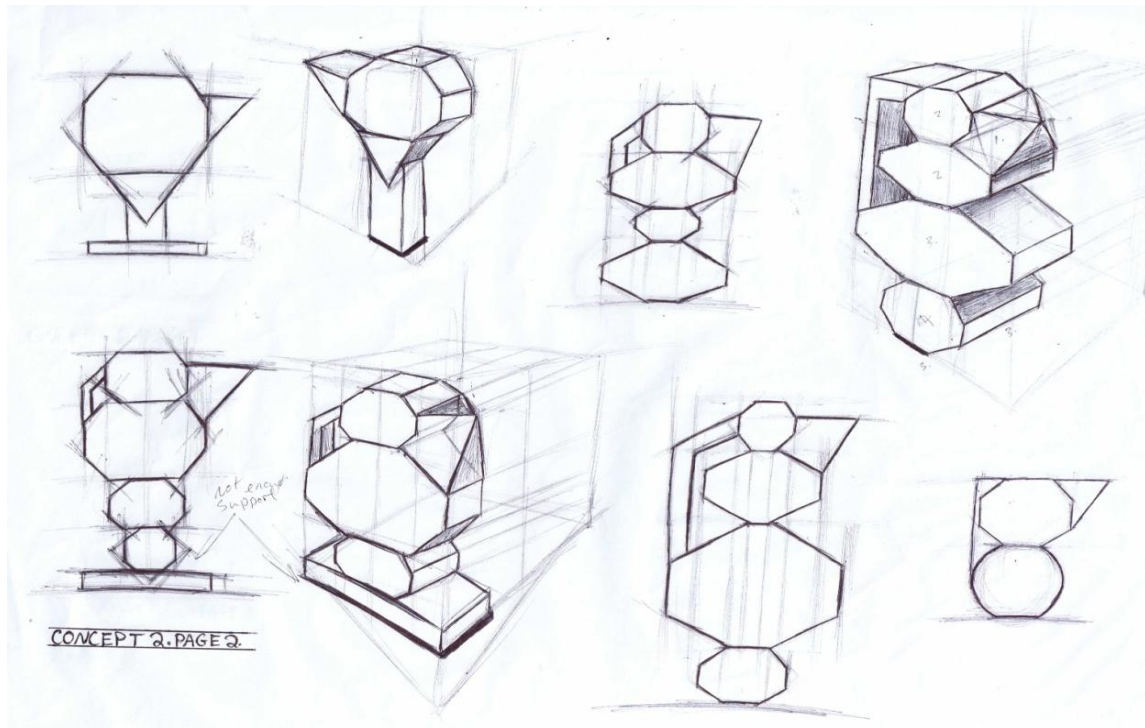
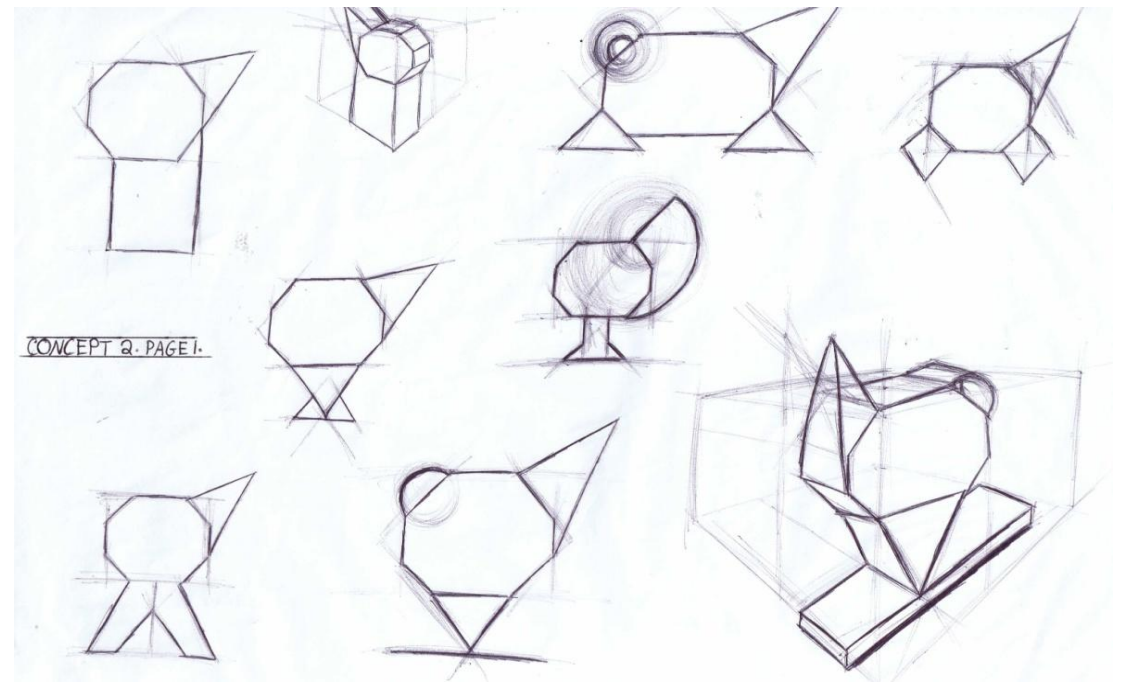

# CONCEPT DEVELOPMENT 3

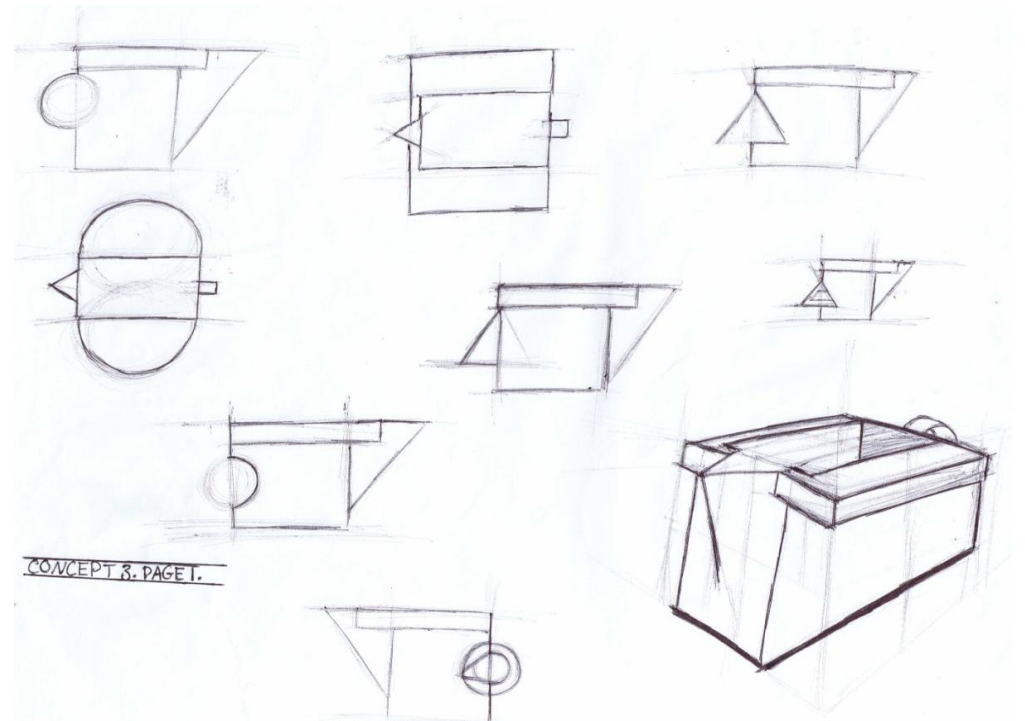
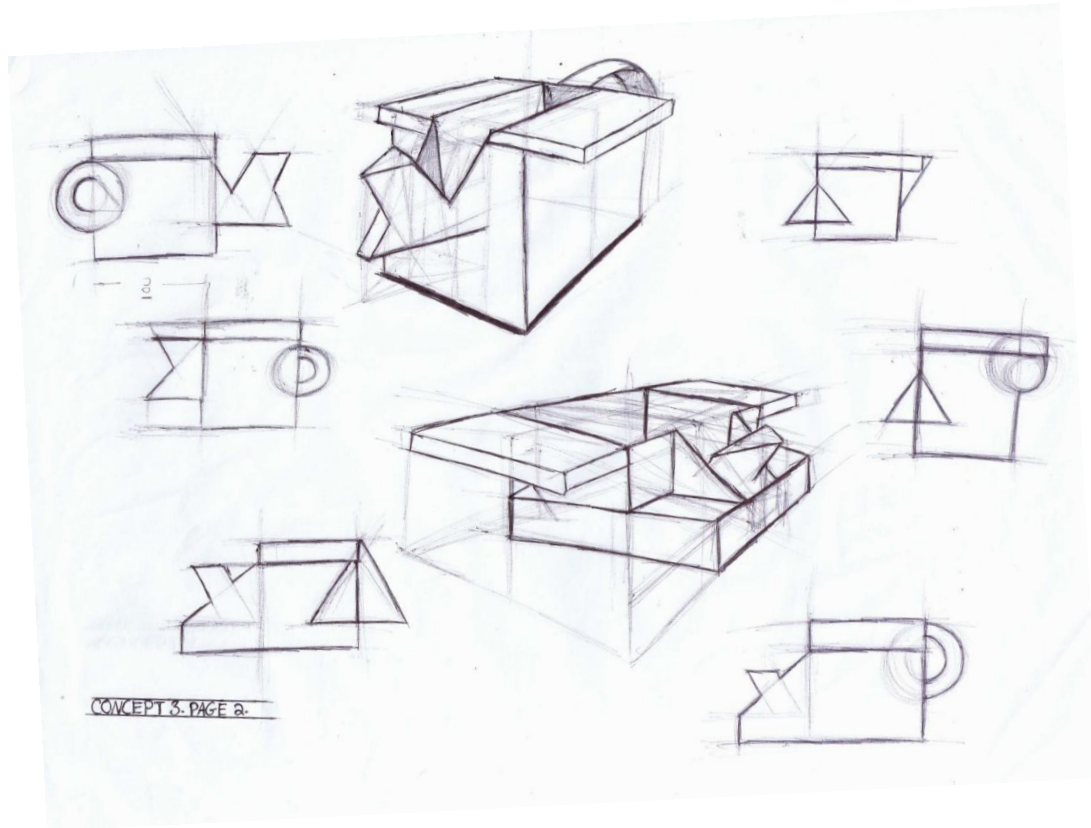

# FINAL PRESENTATION DEVELOPMENT 2

